

Combined Bar Lights **OPT-LIM Series**

Patented



Product Features

- Adjustable illumination angle (0-90°)
- Intensity of each bar light can be individually controlled.
- Suitable for various applications

Application Cases

- PCB inspection
- Electronic component inspection
- Soldering inspection
- Mark positioning
- Microscope illumination
- Package barcode reading

Selection Guide

OPT-LIM6022

- Bar light width
- Bar light length
- Combined bar light
- Brand name

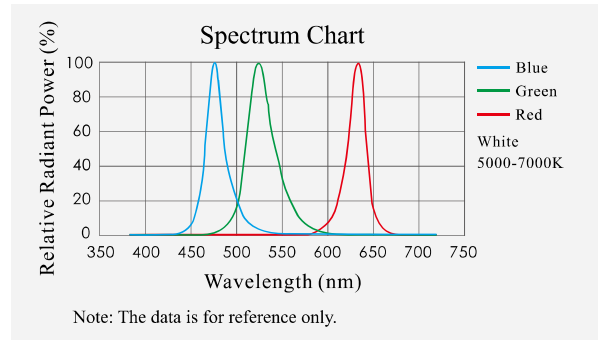

Customizable Items

- Color (RGB)
- Mounting (Screw)
- Polygon (Hexagon)
- Sectional control
- Connector (Circular)
- Size (Ruler)

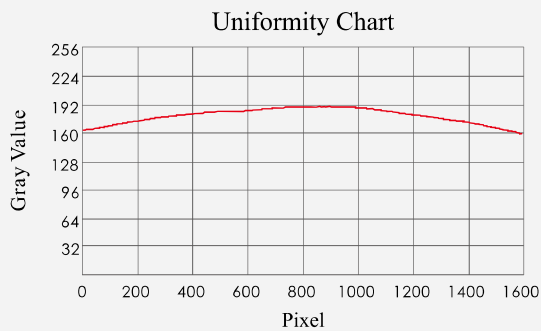

Application Example

- OCR for keyboards

Workpiece → Illumination → Image → SciSmart Analysis Result

Model Table

No.	Model	*Output ●	*Output ○●●	Channels	Recommended controller
1	OPT-LIM6022	24V/2.5W	24V/2.9W	4	OPT-DPA1024E OPT-DPA2024E
2	OPT-LIM11222	24V/3.8W	24V/8.9W	4	
3	OPT-LIM15020	24V/4.8W	24V/12.1W	4	
4	OPT-LIM21230	24V/13.4W	24V/31.2W	4	

* Note: The data is for reference only.

Application Examples

▣ PCB positioning

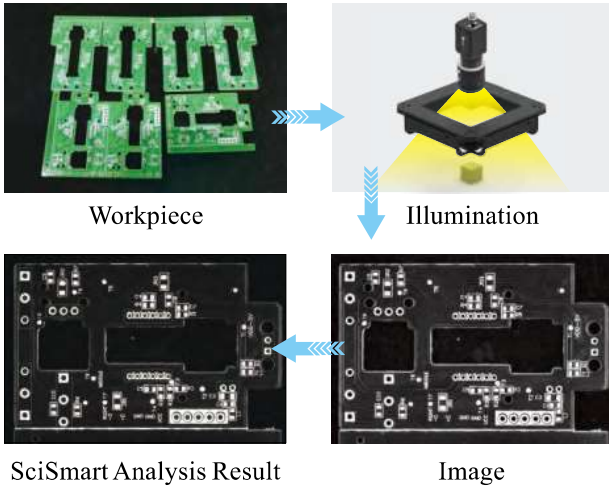

▣ Mark positioning

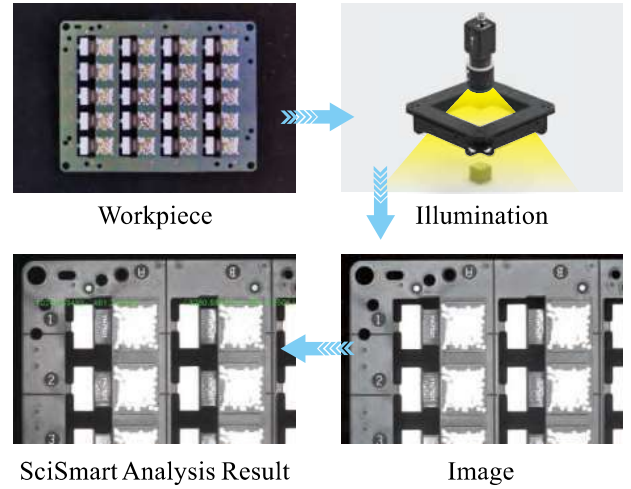

Dimensions (mm)

1.OPT-LIM6022

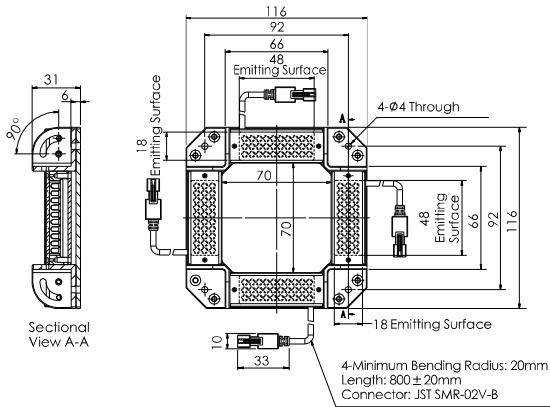

2.OPT-LIM11222

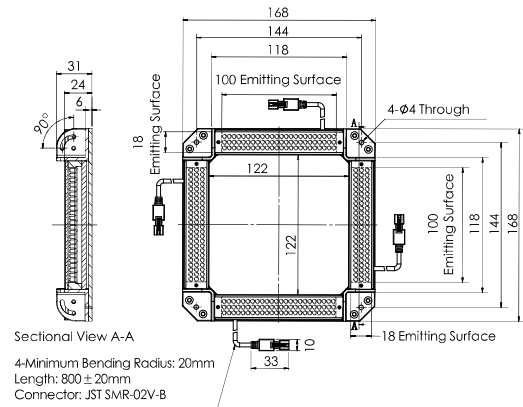

3.OPT-LIM15020

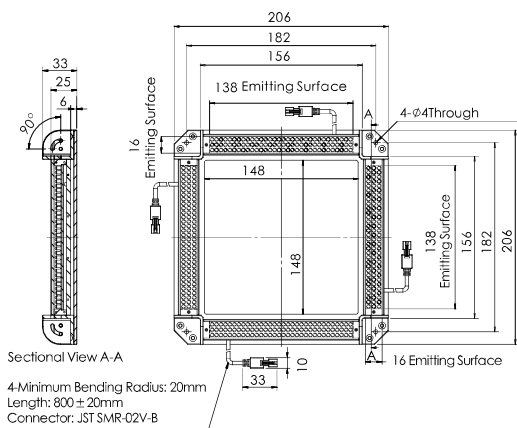

4.OPT-LIM21230

